

MRR-2

Micro Rain RADAR

User Manual



METEK
Meteorologische Messtechnik GmbH

Fritz-Strassmann-Strasse 4
D-25337 Elmshorn
Germany

Fon +49 4121 4359-0
Fax +49 4121 4359-20
e-mail info@metek.de
internet <http://www.metek.de>

Copyright: © 2010 METEK GmbH

All Rights reserved. No part of this manual may be reproduced, transmitted, stored in a retrieval system, nor translated into any human or computer language, in any form or by any means, electronic, mechanical, optical, chemical, manual, or otherwise, without the prior written permission of the copyright owner.

Table of Contents

1	Safety Precautions	3
2	How to use this manual	5
3	Measuring Principle	6
4	System Description	7
4.1	Overview.....	7
4.2	Description of the Components.....	10
4.2.1	Parabolic Dish.....	10
4.2.2	Antenna Heating (Option).....	10
4.2.3	RADAR Control and Processing Device and Transceiver.....	10
4.2.4	Junction Box / Power Supply.....	11
4.2.5	Cable RCPD-Junction Box.....	13
4.2.6	Cable Junction Box-PC.....	13
4.2.7	Control- and Evaluation Computer (PC).....	14
5	Hardware Installation	15
5.1	General Provisions.....	15
5.2	Site Conditions.....	15
5.3	Installation Procedure.....	16
6	Control Program	18
6.1	Installation.....	18
6.2	Using the Control Program.....	18
6.2.1	Main Menu.....	21
6.2.2	Control Commands Menu.....	22
6.2.3	Output Parameters Menu.....	22
6.2.4	Device Parameters Menu.....	25
6.2.5	Parameter Storage.....	27
6.2.6	Status messages and time-axis control.....	29
6.3	Instantaneous and averaged data.....	31
6.3.1	Format description.....	31
6.3.2	Example.....	36
6.4	Raw data.....	39
6.4.1	Format Description.....	39

6.4.2	Example	40
6.5	Removing of the Software	41
7	Detailed description of the MRR-2 control program.....	41
7.1	Communication-, Data-, and Error-Service (CDES)	42
7.1.1	Communication Service.....	42
7.1.2	Data Recording	42
7.1.3	Error Protocol	43
7.2	Control Program User Interface (CPUI).....	44
8	MRR-2 Specifications.....	47

1 Safety Precautions

To operate the MRR-2 a mains voltage of 210-240 VAC is needed for the power supply. An improper handling can be dangerous to you. Only competent and instructed persons should work with this system or with parts of it.

The outdoor installation must not be performed in case of an approaching thunderstorm, to avoid a possibly endangering of personnel by lightning.

There are not known any health hazards originating from the emitted electromagnetic radiation of about 50 mW. Nevertheless you should take care that everybody keeps out of the beam above the antenna (parabolic dish) when it is in operation.

All connecting cables, plugs, and couplings of the MRR-2 are not interchangeable to prevent any erroneous assembly. This safety precaution is disabled if other types of plugs are installed by the user. Therefore any guarantee explicitly expires and METEK accepts no responsibility for injuries to persons, damage of equipment or other consequences connected with not authorized changing of connectors, cables or other parts of the system.

Depending on regional rules for the use of electromagnetic transmitters frequency permission might be necessary. The operator of the system will be liable for the achievement of such permission. However METEK will be of help with providing adequate information. Copies of the certifications for Germany can be found in chapter 6 of this manual.

2 How to use this manual

The delivered hardware items are described in section 4. Make sure that the delivery is complete and free of damage. Consult section 5 for setting up the hardware. In section 6 the installation and use of the control software is described. The technical specifications are listed in section 8.

Section 7 contains more detailed information which is not needed for standard operation.

All auxiliary information marked by a grey vertical line on the left margin may be skipped at first reading as it is not needed for standard setting up and operation.

3 Measuring Principle

The Micro Rain Radar MRR-2 retrieves quantitative rain rates, drop size distributions, radar reflectivity, fall velocity of hydro meteors and other rain parameters simultaneously on vertical profiles up to several kilometers above the radar.

It operates with electromagnetic radiation at a frequency of 24,230 GHz with a modulation of 0.5 – 15 MHz according to the height resolution (e.g. 300 m – 10 m). The radiation is transmitted vertically into the atmosphere where a small portion is scattered back to the antenna from rain drops or other forms of precipitation.

Due to the falling velocity of the rain drops antenna there is a frequency deviation between the transmitted and the received signal (Doppler frequency). This frequency is a measure for the falling velocity of the rain drops. Since drops with different diameters have different falling velocities the backscattered signal consists of a distribution of different Doppler frequencies. The spectral analysis of the received signal yields a power spectrum which is spread over a range of frequencies lines corresponding to the Doppler frequencies of the signal.

The RCPD determines this power spectrum with a high time resolution (25 per second) and sends mean power spectra every 10 s to the connected control and data acquisition system, where the reflectivity spectrum is calculated considering the calibration parameters of the RADAR module. Using known relations between fall velocity, rain drop size and scattering cross section the drop spectrum (or drop size distribution) is derived. The integration over the entire drop size distribution, considering further correction terms, followed by further averaging over 10 to 3600 seconds, results in rain rate and liquid water content.

The output signal of the RADAR is transmitted continuously (CW mode), a linearly decreasing saw tooth modulation of the transmit signal (FM mode) makes it possible to perform profile measurements with selectable range resolution.

The RADAR antenna is an offset parabolic dish with vertical beam orientation. This antenna design allows rainwater to drain without building ponds. In order to avoid disturbances from snow, which could cover the antenna dish, optional antenna heating is offered.

4 System Description

4.1 Overview

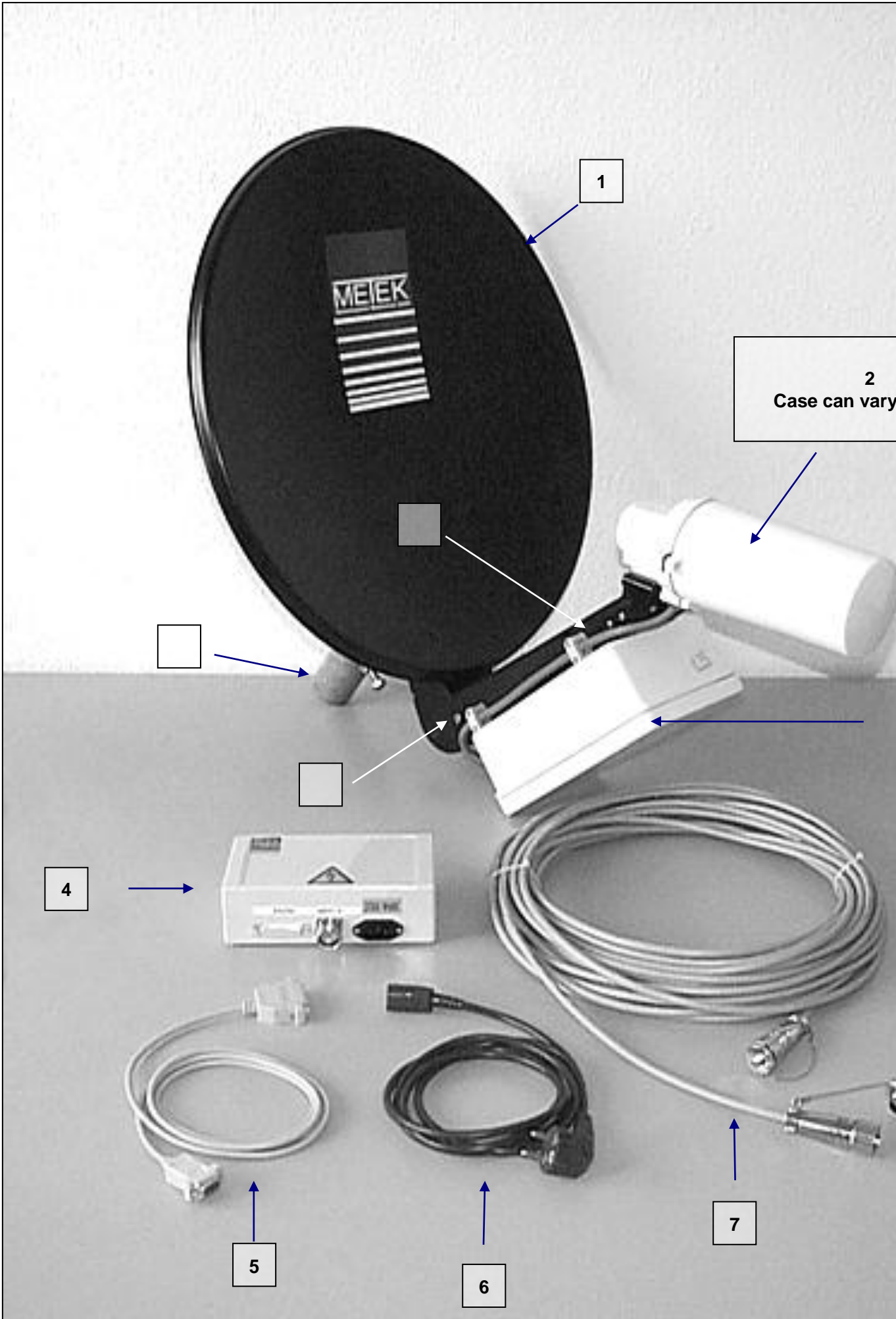

The Control- and Evaluation Computer, a commercial PC, (not part of delivery) must be ordered separately. The operating system must be Windows® 2000 or XP. (Windows® Vista and Windows 7 is not supported).

4.2 Description of the Components

4.2.1 Parabolic Dish

The antenna is used for the transmission of the RADAR signals and the receiving of backscattered signals. It is designed as an offset parabolic dish (1). Its largest diameter is 70 cm, the beam width is 2°. Due to the offset-design of the parabolic dish rainwater can drain off.

For antenna mounting the tube socket (10) (inner $\varnothing = 49.4$ mm, outer $\varnothing = 54.4$ mm) is to be plugged onto a pole with an outer diameter of max. 49 mm. The socket is fastened with an M10 screw (10 mm \varnothing).

Connect a ground wire to this screw which serves as a surge protector.

The pivot (9) is factory-adjusted, so that vertical orientation of the mounting tube socket results in a vertical orientation of the antenna beam. (Ignore the scale on the pivot).

The parabolic dish must not be moved in its pivot (9), because this would cause beam deviations from vertical and would result in erroneous measurements.

The transmitting and receiving properties of the antenna affect the radar calibration. Therefore the reflector surface should be clean (e.g. free from leaves or wet snow). For the same reason any mechanical deformation of the parabolic dish must be avoided. If nevertheless obvious deformation occurred, the reflector must be replaced.

4.2.2 Antenna Heating (Option)

+

Figure 2: Antenna Heating

The back side of the reflector is optionally equipped with a heating coil. It is covered and sealed with a molded lid (11) which provides also extra stability for the reflector. The energy consumption increases with decreasing temperatures and amounts to maximum 500 W. The heating is activated when the temperature falls below a threshold which can be adjusted in the heating-junction box (13). The heating coil works with 230 VAC voltage supply and needs an extra power cable which is connected to (1).

4.2.3 RADAR Control and Processing Device and Transceiver

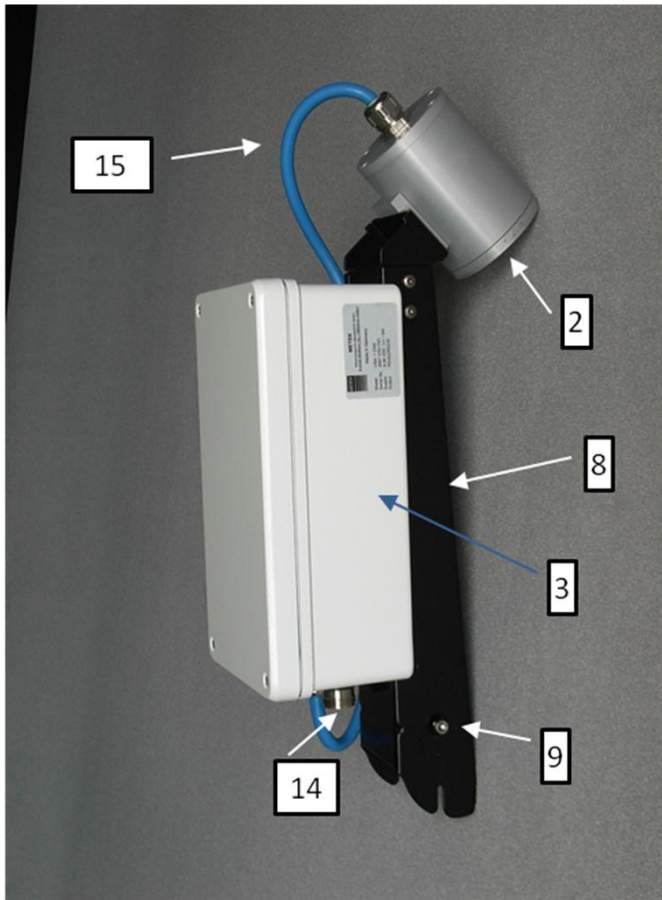

Figure 3: RCPD and Transceiver

The RCPD (3) generates the RADAR transmit modulation signal and passes it to the transceiver (2) through cable (15). It analyses the backscattered receiver signal, calculates Doppler spectra and transfers average power spectra (referred to as “raw data”) to the control and evaluation PC, where these spectra are interpreted. The RCPD is located in a water protected IP65 housing, which is fixed to the antenna arm (8). At the bottom side of the RCPD is the socket (14) for cable (7). The electronic components inside the housing don't need any service. As far as possible the RCPD should not be opened by the user.

4.2.4 Junction Box / Power Supply



Figure 4: Junction Box Left:Front Side, Right: Back Side

The junction box is used to pass through the communication between the PC and the RCPD. For this purpose it has a 25-pin D-sub-miniature socket, (16) for the data cable (5) to the PC and a flanged socket (17) for the cable (7) to the RADAR RCPD (3).

The power supply for the RCPD and Transceiver is also integrated in the junction box. An IEC connector for the mains supply of 230 VAC (17) is on the front side of the case. On the back side are two sockets for banana plugs for the connection of an alternative external DC power supply (19). The power supply (24 VDC) for the RCPD and Transceiver is also passed through cable (7).

Note : The junction box is not appropriate for outdoor operation.

4.2.5 Cable RCPD-Junction Box

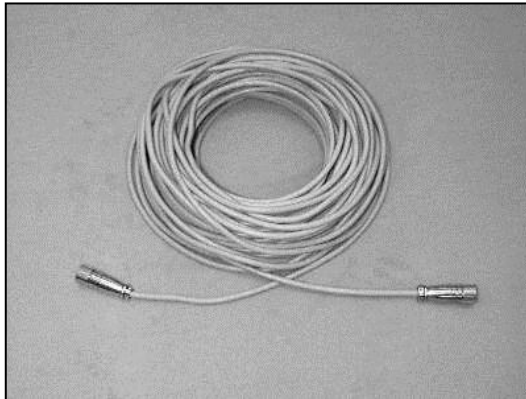

Figure 5: Cable between Junction Box and RCPD

The cable has a length of 25 m, on both ends are screwed plugs (male and female respectively). They must be screwed onto the matching plugs at the junction box (cable has pins) and at the RCPD (cable has sockets).

4.2.6 Cable Junction Box-PC

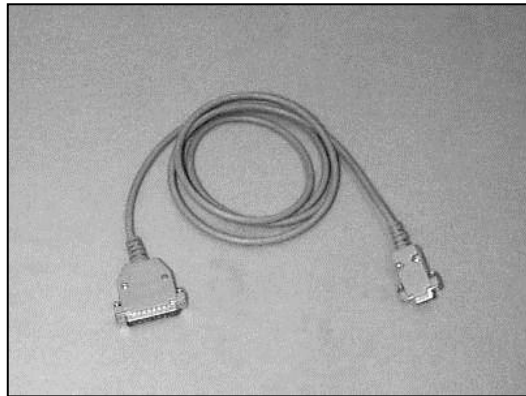

Figure 6: Cable Junction Box-PC

Data cable with a 9-pin (female) and a 25-pin (male) plug and a length of 1.5 m is delivered. This cable is not appropriate for outdoor applications.

4.2.7 Control- and Evaluation Computer (PC)

A personal computer (PC) with the operating system Windows® 2000 or XP serves for setting the operation parameters and data evaluation of the MRR. (Windows® Vista and Windows® 7 are not supported).

The PC must have at least one serial port which will be configured by the control program as follows:

57600 baud,
8 data bits, no parity,
software protocol (XON/XOFF), no hardware protocol (handshake).

Pinning (D-Sub-25-socket at the device) :

Pin 2	RD	<i>received data</i>	to the device
Pin 3	TD	<i>transmitted data</i>	from the device
Pin 7	GND	<i>ground</i>	

The control program which is needed to operate the MRR-2 is part of delivery. Its installation and operation is described in section 6 *Control Program* page 18.

5 Hardware Installation

5.1 General Provisions

- Before you start the system, all cable connections must be set up.
- Only the antenna unit including RCPD, Transceiver and cable (7) are designed for outdoor operation. All other components, e.g. the junction box and PC, must be installed in a weather protected environment with temperatures within 5 - 50 °C.
- The electronic cases may be opened only in dry environment. Especially in outdoor area you risk damage by moisture.
- If cables are laid on free field, a cable conduit is recommended.
- All cable connections should be protected by strain-reliefs.
- Use only the original connectors. Guarantee is void, if other connectors are installed.

5.2 Site Conditions

Before actual installation the site must be checked for its suitability for rain measurements.

There must be free view of at least 10° zenith angle over the radar.

Nearby transmitters (base stations of mobile phones, broadcast towers, radars) can cause interference although they operate nominally at different frequency bands. If such neighborhood is necessary, a simple metallic screen or larger object (container) obscuring the direct line of sight to the interfering source can help.

The vicinity of electric machines (e.g. drive of elevators) should be avoided, since they can create interfering signals which are difficult to screen.

If measurements at very low heights are planned, (with appropriate settings the MRR-2 allows measurements from a minimum height of 20 m above ground) take care that the wind field in this level is not disturbed by nearby buildings, trees, masts etc., because strong turbulence could falsify the data.

In contrast with in-situ rain sensors the exposure of the antenna to the free wind field is not detrimental but favorable.

Figure 7 shows various examples of MRR installations: On ground, on top of containers and on top of buildings.



Figure 7: Examples of MRR installations

5.3 Installation Procedure

Preparations:

A fixed vertical pole (\varnothing max. 49 mm, length min. 30 cm) is required for attaching the antenna. Operating of the MRR-2 requires a 230 VAC mains supply, with a fuse protection of 8 A (slow) minimum. To prevent disturbance of the device by variations or breaks of the power supply we recommend the use of a no-break power supply (UPS).

Required Tools: A wrench with 17 mm opening.

Installation Steps:

1. Install the control and evaluation computer (PC) according to the documents of the manufacturer.
2. Plug the tube socket (10) of the RADAR antenna over the attachment pole and clamp it with the M10 fixing bolt.
3. Check the vertical alignment of the antenna with the built in bubble level (see Figure 8)

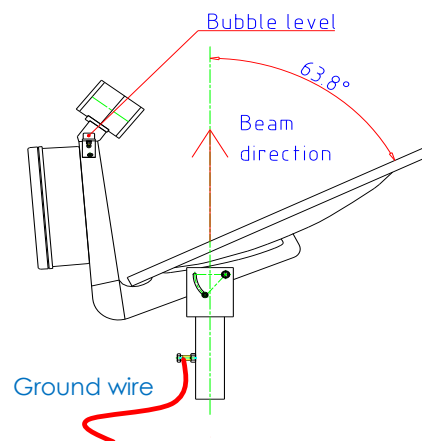

Figure 8: Vertical alignment of the radar beam

4. Attach a ground wire to the fixing bolt for lightning protection.
5. Connect cable (7) between RCPD and Junction Box after mounting of the antenna.
6. Connect cable (5) to that serial interface of the computer, which was selected in the operating system for the connection of the MRR-2. If this serial port is unknown, it can be looked up in the administration of the "services" in the operating system of the computer and it can be changed accordingly there. See also installation of the control program page 18 ff.
7. Connect cable (6) of the Junction Box to the mains voltage of 230 VAC (cable (6)).
8. Establish the communication between the control program „MRR-2 Control” and the RCPD-firmware.
9. Check the correct data transmission and recording.

6 Control Program

If the PC for controlling the MRR-2 with was not ordered separately the programs for controlling the MRR-2 and for data recording are delivered on a CD-ROM and must be installed on a PC with operating system **Windows® 2000 or Windows® XP**. (Older Windows® versions, Windows® Vista, or Windows® 7 are not supported.)

If the PC was configured and delivered by METEK (optional) 6.1 **Installation** may be skipped.

6.1 Installation

For installing the Control Program:

- Insert the CD-ROM.
- Login as administrator.
- Open the program group `my computer` (icon on the desktop).
- Open the folder for the CD-ROM device.
- Change to the folder `METEK\MrrCtrl`.
- With the right mouse key click on the file `MrrXXXXXX.inf`.
- Activate the install menu. The files are copied and the registry of the PC is updated.
- When the copy process has finished, reboot the PC.

Note: The data flow rate from the MRR to the PC requires that the PC response time does not exceed certain limits. If the PC was configured and delivered by METEK (optional), meeting of this request is warranted. Any modern PC with medium performance is basically sufficient to run the Control Program without flaws, if there are not too many other tasks running simultaneously. Particularly virus scanning programs may slow down the PC below the minimum possible value. In that case the data records are corrupted. Check the integrity of recorded data by visual inspection or by some automated procedure.

6.2 Using the Control Program

After login to the operating system open a command line window and enter the command `MrrCtrl.exe`. The following dialogue window appears (The screenshots in this manual were taken from a Windows® 2000 system.):

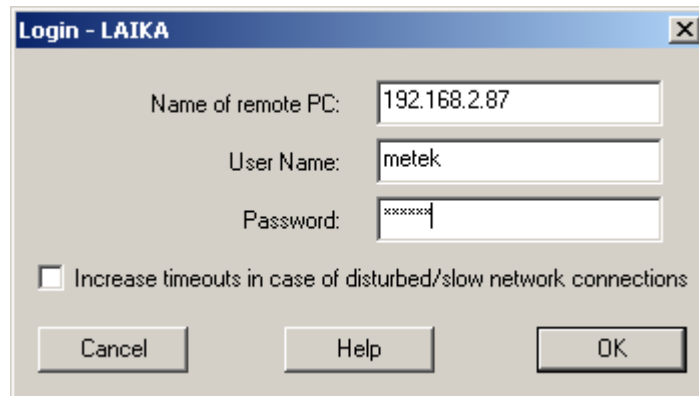

Figure 9: Login Screen

If you are sitting at the PC which is directly connected to the MRR-2 leave the entry at **Name of the Remote PC** empty (or type a period or the name of the local PC). If you are sitting at another PC, enter the name of that PC to which the MRR-2 is connected directly and where the communication service (`MrrCtrl.exe`) was started.

The User Name is generated automatically and the Password is usually not needed (see below for exceptions).

The **Password** entry field is useful if the remote computer is a member of another Windows domain, because in this case a connection can be built up only if a user name and the matching password is given. The user name is set automatically (see the header of the dialog window).

The network connection to the remote computer usually is a LAN- or a RAS connection. RAS connections using the public telephone net are mostly not very efficient, especially connections with mobile phone radio nets. Considering that, the login dialog provides the use of time-out-values which are adjusted to the maximum delay times for the responses from the remote PC. Using a direct LAN or a local login, this feature is not needed.

If the program was started by a command line input, the information concerning the login window can be handed over as a parameter. Example:

```
C:\METEK\MrrCtrl hostname secret /t
```

This entry would try to build a connection to a computer with the name `\\hostname`. The password is `secret`, the time-out-values are set for slow WAN connections (`/t`). The parameter `/t` is optional, the computer name and the password however must be given always. This is also valid for local logins (the password will not be checked).

If the connection to the communication service could be built up, the entire status of the MRR-2 is read out first. This can take some seconds, on RAS connections even some minutes.

Click the OK button

The MRR-2 status is read out which takes some seconds (in case of slow remote communication even some minutes). Then the Main Menu will appear.

6.2.1 Main Menu

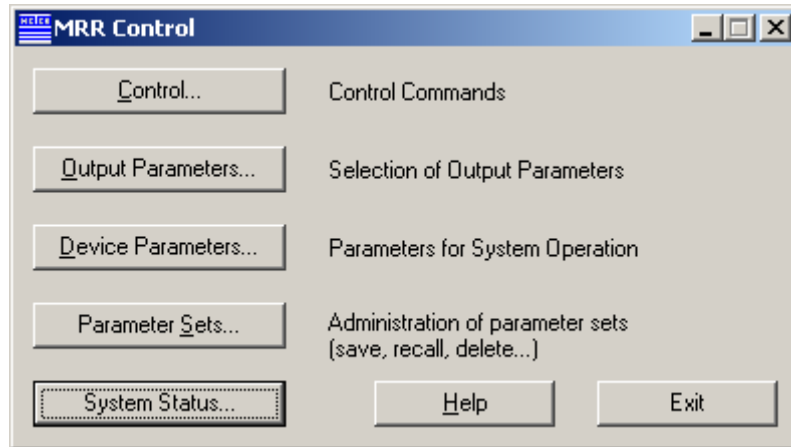

Figure 10: Main Menu

The main menu shows buttons for the menus

<i>Control</i>	chapter 6.2.2 on page 22
<i>Output Parameters</i>	chapter 6.2.3 on page 22
<i>Device Parameters</i>	chapter 6.2.4 on page 25
<i>Parameter Sets</i>	chapter 6.2.5 on page 27
<i>System Status</i>	chapter 6.2.6 on page 29

You can leave the program with the ***Exit*** button.

The ***Help*** button provides a Windows conforming help text.

6.2.2 Control Commands Menu

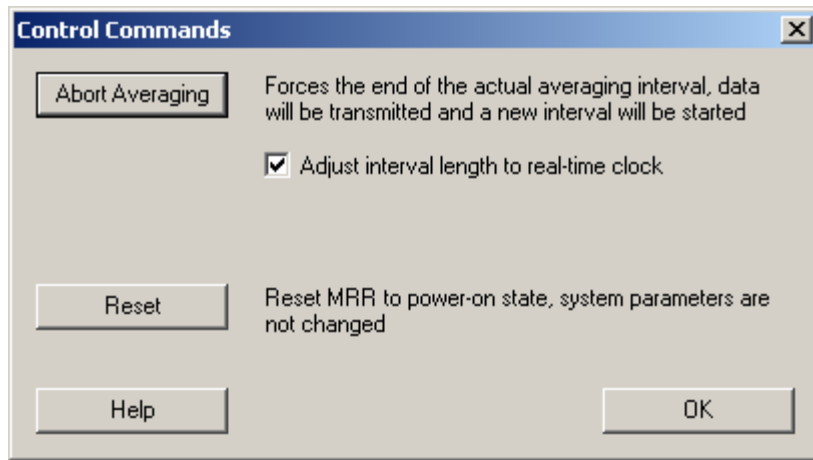

Figure 11: Control Commands

Abort Averaging

The current averaging interval is stopped. Data, collected since the begin of the averaging interval, are processed and a new averaging interval is started regardless of elapsed averaging time.

Adjust interval length to real time clock

This checkbox activates the synchronization of measuring intervals to the actual time of day. This means every output of averaged data will occur at 'round' times. Example:

If the measuring time has been set to 600 seconds, output will be generated at every full 10 min.

Reset

Pressing this button will perform a reset of the RCPD firmware. There is no influence on the MRR-2 parameters. It has the same effect as an interruption of the power supply.

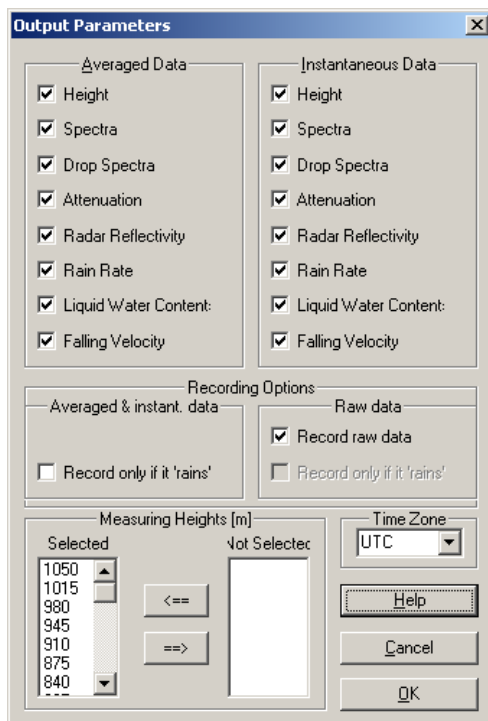

6.2.3 Output Parameters Menu

Figure 12: Output Parameters

The two upper panels shown in Figure 12 contain check boxes for configuring selections of *averaged data* and *instantaneous data* separately for recording. *Instantaneous data* are processed on the basis of one raw spectrum¹. *Averaged Data* are processed on the basis of an average of multiple raw spectra, depending on the selected averaging time. The selectable variables are described in the table below.

Selection of	causes the recording of
<i>Height²</i>	Measuring height above ground
<i>Spectra</i>	Spectral volume reflectivity
<i>Drop Spectra</i>	Drop diameter and number of drops per volume and diameter
<i>Attenuation</i>	Two way path integrated attenuation
<i>Radar Reflectivity</i>	Radar reflectivity factor and attenuated radar reflectivity factor
<i>Rain Rate</i>	Vertical volume flux of liquid water per unit area
<i>Liquid Water Content</i>	Mass of liquid water per volume
<i>Falling Velocity</i>	Doppler velocity (1. moment of the spectrum)

¹ Since the raw spectra and the instantaneous data represent already averages over 10

² The output variable *Height* should always be selected, as this facilitates further processing of recorded data.

Recording Options

Raw data

By checking “Record raw data” the raw spectra including metadata are written in addition to other selected data to a separate log-file. The path name of these log-files is defined by the parameters RawDataFile , RawDataPath.

Conditional recording

By checking “Record only if it rains” no data are recorded, if the evaluation software does not detect precipitation in any measuring height during the measuring (averaging) interval. This condition can be activated separately for averaged/instantaneous data and raw data respectively.

Measuring Height(s)

A subset of measuring heights can be selected for recording. This subset is used for both kinds of data output, instantaneous and averaged data. The selection of measuring heights for output is done with two lists containing the selected and unselected height steps. To move items (sets of height steps) between the lists they must be marked in the source list. The movement will be performed when the arrow button pointing to the other target list is pressed. (The *height resolution* (step-width) can be adjusted with the device parameters menu (see chapter 6.2.4 on page 25)).

Time Zone

The time zone can be selected which is used for the time stamps of the recorded data.

All changes in the Output Parameters Menu become effective by clicking the “Ok” button. Then the corresponding commands are transmitted to the RCPD firmware. Clicking the “Cancel” button cancels all changes.

6.2.4 Device Parameters Menu

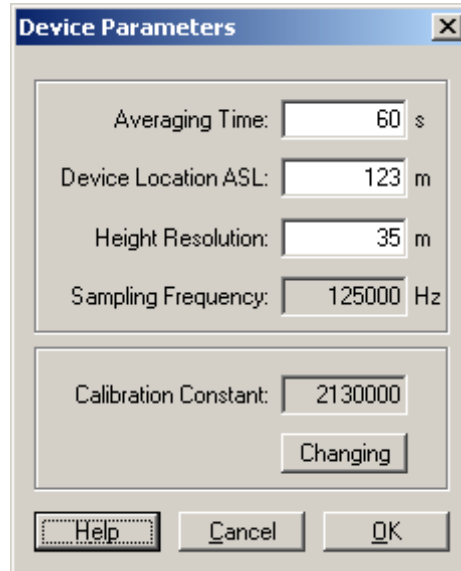

Figure 13: Operation Parameters

Averaging Time

Here you define the averaging time for the *averaged data*.

The adjustable range is 10 .. 3600 s

After each averaging time, an *averaged data* set is generated and recorded and a new averaging interval starts. Instantaneous data are generated and recorded independently in 10 s time intervals within each averaging interval.

Device Location ASL

Enter the height of the MRR-2 location above sea level.

The adjustable range is 0 ... 9999 m.

This parameter is used for the density correction of the fall speed versus drop size relation.

Height Resolution

Enter the desired distance between adjacent measuring heights (step width).

The adjustable range is 10 - 1000 m. Typical values are 30 – 100 m.

The measuring heights are integer multiples of the height resolution. The maximum number of height steps is 31.

Sampling Frequency

Number of samples per second of the analogue input signal of the MRR-2. This parameter can't be changed by the user.

Calibration Constant

This constant is needed for converting the engineering units of the receiver signal (raw data) into physical units (instantaneous and averaged data). See Physical Basis for details. The calibration constant is factory set. Nevertheless it can be changed by the experienced user. Before a new calibration constant can be entered the “changing” button must be pressed. It should be only done, if there is clear evidence for a miss-calibration of the MRR. This can be inferred for example from rain rates measured with the MRR (R_{MRR}) and a rain gauge (R_{RG}) respectively. If C_{old} is the old calibration constant, the new calibration constant C_{new} can be calculated according

$$C_{new} = C_{old} \frac{R_{RG}}{R_{MRR}}$$

It should be kept in mind that comparisons of rain rates measured aloft with the MRR and a rain gauge are not straightforward due to the strong inhomogeneity of rain. MRR data should be taken from range gates not below the 3rd range gate, because approximations in the radar equation cause larger biases at lower range gates. On the other hand the measuring height should not exceed 200 m in order to keep attenuation effects small (they are only eliminated in case of correct calibration) and to keep the correlation with surface precipitation at a useful level. Further make sure that the MRR rain retrieval is not affected by the ice phase or melting processes. Strong winds should also be avoided since rain gauges tend to unreliable under such conditions.

OK

All changes in the Device Parameters Menu become effective by clicking the “OK” button. Then the corresponding commands are transmitted to the RCPD firmware. Clicking the “Cancel” button cancels all changes.

6.2.5 Parameter Storage

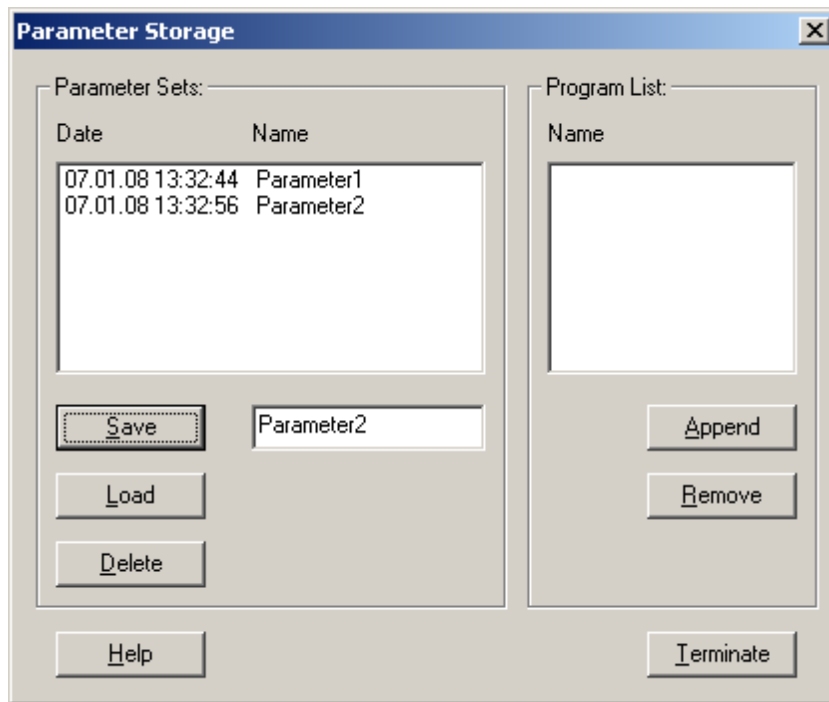

Figure 14: Parameter Storage

Parameter Sets

The parameter memory of the MRR-2 is used for convenient saving and loading of complete parameter settings.

A parameter set consists of

- the device parameters (except calibration constant) and
- the selected output parameters

Saving a parameter set:

- Type a name in the field right of the **Save**-button or select a name of the Parameter Sets list.
- Click the **Save**-button.

Loading a parameter set:

- Type a name of the Parameter Sets list in the field right of the **Save**-button or select a name of the Parameter Sets list.
- Click the **Load**-button.

Deleting a parameter set:

- Type a name of the Parameter Sets list in the field right of the **Save**-button or select a name of the Parameter Sets list.
- Click the **Delete**-button.

Program List

Previously defined parameter sets can be added to a program list. All sets, which are included in this list, will be processed successively. This means every time the averaging interval has finished, the next entry will be loaded from the list. After reaching the end of this list, the program starts over with the first entry.

Creating a Program List

- Select a parameter set in the Parameter Sets list
- Click the **Append** button. The parameter set is inserted in the empty Program List or added to the end of the non-empty Program List.

As soon as the Program List is not empty, it becomes active.

Removing entries from the Program List

- Select the entry from the Program List
- Click the **Remove**-button

Note:

1. Parameter sets, which appear in the Program List can neither be changed nor deleted.
2. The same parameter set name may appear at several places in the Program List.

6.2.6 Status messages and time-axis control

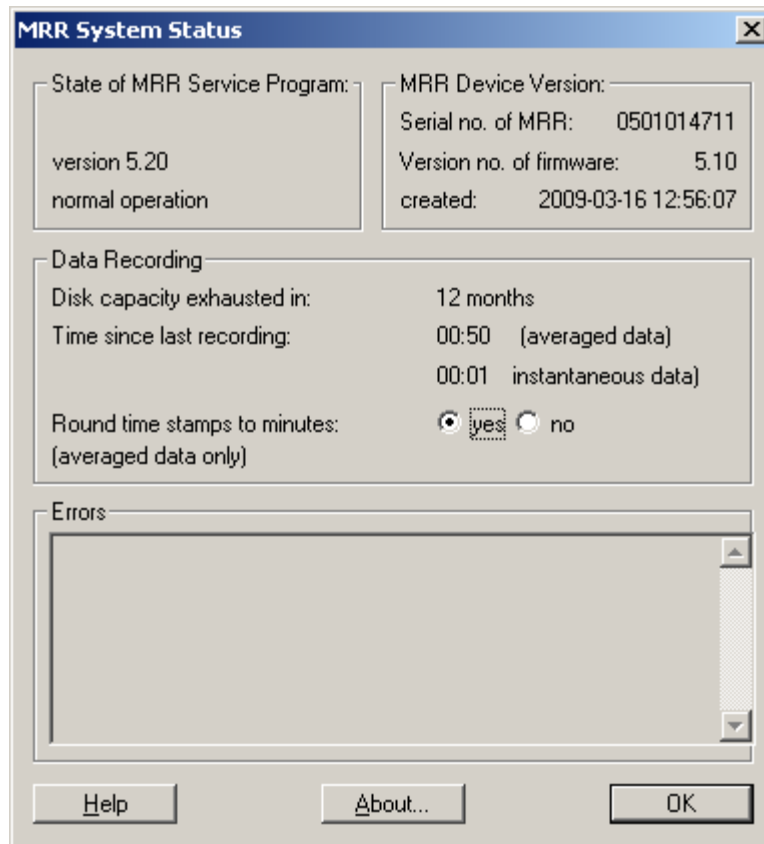

Figure 15: System Status

Sub-Panel: "State of the MRR Service Program"

The version number of the MRR service program is shown.

The operation state is shown:

- *normal operation*
No problems occurred.
- *erroneous operation*
One component of the service could not be installed. Either a hardware error or a conflict between programs occurred (Example: Two programs attempt to access the same port.)

Sub-Panel: "MRR Device Version"

The serial number, the firmware version number and the firmware creation date of the connected MRR are shown.

Sub-Panel: “Data Recording”

Disk capacity exhausted in The remaining time for data recording is shown. The calculation is based on the average sizes of the last received measuring protocol and the actual free disk space (Initially ??? appears until the first data set is stored).

Time since last recording The time elapsed, since the last averaged and instantaneous data sets were written to disk, is shown (Initially ??? appears until the first data set is stored).

Round time stamps to minutes Time stamps are rounded to integer values. This can be useful under the following condition: If the "Adjust interval length to real time clock" (see chapter 6.2.2 **Control Commands Menu**) was selected, the time stamps should be integer multiples of 10 seconds, minutes or ten minutes. Nevertheless small deviations from these integers may occur due to variable processing time. If this is disturbing for subsequent data analysis programs, the recorded time stamps can be rounded. The selection yes or no is activated by pressing the *ok* button.

Sub-Panel “Errors”

This panel shows a list of errors which occurred during the measuring operation. Errors which occurred before the control program was started can be retrieved from the Windows® 2000- or Windows® XP-event log.

About Button



Figure 16: This panel appears after clicking the *About*-button

6.3 Instantaneous and averaged data

6.3.1 Format description

Instantaneous and averaged data are archived in two separate directory structures (see chapter 7.1.2 Data Recording on page 42). Optional recording of so called raw data, which represent the unprocessed measuring data of the MRR-2, is only useful for special purposes.

The data format is human readable ASCII text. Each data set consists of one line. The order of the data lines and the used identifiers are listed below:

Identifier	Meaning	Unit	Remark
MRR	<i>Header Line</i>	n.A.	
H	<i>Height</i>	m	
TF	<i>Transfer Function</i>	dimensionless	
Fnn	<i>Spectral Reflectivities</i>	dB	$10 \cdot \log \eta_{nn}$ with η_{nn} in m^{-1} nn from $\min(h)$ to $\max(h)$ ³
Dnn	<i>Drop Size</i>	mm	Center of size class
Nnn	<i>Spectral Drop Densities</i>	$\text{m}^{-3}\text{mm}^{-1}$	$N(D_{nn})$ ³
PIA	<i>Path Integrated Attenuation</i>	dB	
Z	<i>Radar Reflectivity</i>	dBZ	$10 \log \left(\sum_{nn=\min(h)}^{nn=\max(h)} N(D_{nn}) D_{nn}^6 \right)$ nn from $\min(h)$ to $\max(h)$
z	<i>Attenuated Radar Reflectivity</i>	dBZ	Z-PIA
RR	<i>Rain Rate</i>	mm h^{-1}	
LWC	<i>Liquid Water Contents</i>	g m^{-3}	
W	<i>Fall Velocity</i>	m s^{-1}	

¹⁾ See *MRR-Physical Basics* for details.

The measured data are displayed in lines following the header. For each measured variable there is one line starting with a 3-character identifier of the variable. Each line represents a profile of this variable, i.e. a function versus height. Each data entry is 7 characters wide. Height is running from left to right

³ See *MRR-Physical Basics* for details.

in increments according to the chosen height resolution of the MRR. Invalid or not calculable values are coded as 7 consecutive space characters. Space characters-at the end of a line are omitted in order to save disk space. So lines can have different lengths although representing the same number of height steps.

MRR – Header Line

The header line marks the beginning of a data set. It starts with the identifying string "MRR", a space character and a date/time stamp.

The date/time stamp consists of 12 digits (format *YYMMDDhhmmss*), a single space character and the name of the time zone. This name starts with the string „UTC“ and is optionally followed by an offset value (format $\pm hh$ or $\pm hhss$).

Averaging time in seconds ("AVE"), (Not in instantaneous data).

height resolution in meters ("STP"),

height of the ground level above sea level in meters ("ASL"),

sampling rate ("SMP") of the RADAR signal in the time domain (unit: Hz),

parameters for the automatic noise level adjustment ("NF0" and "NF1" without unit),

version number of the MRR Service ("SVS"),

version number of the MRR firmware ("DVS"),

serial number of the MRR ("DSN")

calibration constant ("CC")

data quality parameter consisting of the identifying string "MDQ", a single space character and a 3digit number between 0 and 100. It is the percentage of valid spectra collected during the averaging interval. Spectra can be invalid due to saturation of the AD converter – caused either by extreme precipitation or by some interference

Each of the parameters in the header line starts with a delimiting space character, the 3-character identifier as shown above in the parentheses and a field of 6 characters for the numerical value (except of the serial number, which can consist of up to 10 numeric characters between 0 and 9).

Example (Each entry of the header line is shown in a separate line of the table) :

MRR*090612040200 UTC	The header line dates from June 12 th , 2009, 4:02 AM, UTC.
AVE***60	Averaging time is 60 seconds.
STP***35	Height resolution is 35 meters.
ASL***147	The radar is sited 147 meters above sea level.
SMP*125e3	Sampling rate is 125,000 Hz.
NF0*1.000	Noise level 0 set to 1.000 (used only in older versions).
NF1*0.000	Noise level 1 set to 0.000 (used only in older versions).
SVS*5.2.0.9	Version number of the MRR Service is 5.2.0.9
DVS*5.13	Version number of the MRR firmware is 5.13.
DSN*020704	Serial number of the MRR is 020704.
CC*2066000	Calibration constant is 2066000.
MDQ 100	Percentage of valid spectra is 100

H - Height

Argument of the following data profiles corresponding to the settings described in chapter 6.2.3, page 22, and chapter 6.2.4, page 25. The units are meters above the radar system.

TF - Transfer Function

To each height step a value of the Transfer Function is assigned by which raw data are divided.

Fnn with nn from 0 to 63 - FFT Spectra

Each line represents a profile of spectral reflectivity corresponding to the spectral bin *nn*. As **Fnn** is corrected for the receiver noise floor negative values can occur, if the signal to noise ratio is low. These entries cannot be presented in the logarithmic domain and are replaced by space characters.

Dnn with nn from min(h) to max(h) - Drop Sizes

The drop size is described by the diameter of an equivolumic sphere. The spectral bins of drop numbers are of variable width in the size domain (in contrast with spectral bins in the frequency- and velocity-domain). In addition, the widths of the size bins are slightly height dependent. Therefore the assignment

of frequency-bin-index nn to diameter D is listed explicitly for each bin and height. The center of each size class is displayed.

Nnn with nn from $\min(h)$ to $\max(h)$ - Spectral Drop Densities

With the knowledge of the frequency of the Doppler-shift the calculation of the corresponding drop fall velocity is possible (equation 1.4.3.2 in MRR Physical Basics). Thus each FFT-line stands for a drop size interval. Chapter 2 in the Physical Basics shows how to derive from the received spectral power the number of drops for this drop size class, and finally – by division through the variable class width – the spectral drop densities.

Only a sub-set of all 64 spectral bins is considered for the calculation. The lower ($\min(h)$) and upper limit ($\max(h)$) depends on the height as described in MRR Physical Basics (Fig. 7).

In case of negative values of F_{nn} negative drop number densities are calculated. Although they have no physical meaning they are retained in order to avoid statistical biases.

PIA - Path Integrated Attenuation¹⁾

The two-way Path integrated attenuation by rain drops is calculated as described in chapter 3.2 MRR-Physical Basis and is used for correction of N_{nn} , Z , RR and LWC .

z - Attenuated Radar Reflectivity²⁾

z is the radar reflectivity factor (see chapter 3.1 MRR-Physical Basics) without attenuation correction

Z - Radar Reflectivity²⁾

Z is the radar reflectivity factor (see chapter 3.1 MRR-Physical Basics)

RR - Rain Rate²⁾

RR is the rain rate (see chapter 3.3 MRR-Physical Basics)

LWC - Liquid Water Content²⁾

LWC is the liquid water content (see equation 3.2.1 MRR-Physical Basics)

²⁾ *In case of low signal to noise ratio negative values can occur. Although they have no physical meaning they are retained in order to avoid statistical biases.*

W - Fall Velocity

W is the characteristic falling velocity.

(First Moment of the Doppler spectrum, see chapter 3.4 MRR-Physical Basics).

The width of velocity-bins can be derived from the maximum number of height steps, the sampling rate (as shown in the header line) and the wave length of the RADAR signal. 32 height steps and 64 lines per step are calculated. For a sampling frequency of 125 kHz and a transmit frequency of 24.23 GHz, the resolution of the fall velocity can be calculated as:

$$\frac{125 \text{ kHz}}{2} \frac{1}{32 \cdot 64} \frac{299700 \text{ km/s}}{2 \cdot 24 \text{ GHz}} = 0,1887 \text{ m/s}$$

F59-101.35-109.38	-106.55	-94.94	-93.66	-89.85	-93.59	-89.22	-86.48	-92.83	-89.13	-88.15	-87.38	-86.91	-86.30	-87.35	-84.84	-84.90	-86.03	-88.15	-83.88	-81.63	-82.16	-80.38	-78.67	-78.18	-77.11	-78.68	-78.96			
F60 -97.25	-98.23	-106.60	-102.53	-108.97	-94.12	-93.94	-91.66	-92.15	-87.70	-91.76	-87.39	-86.05	-86.21	-86.36	-85.50	-86.28	-84.29	-84.31	-84.44	-87.38	-84.13	-81.27	-80.91	-79.17	-77.69	-77.71	-76.41	-77.96	-79.56	
F61 -85.64	-91.97	-96.80	-97.21	-106.05	-94.75	-93.78	-92.73	-97.00	-88.49	-91.78	-87.16	-85.21	-85.92	-84.83	-85.50	-86.38	-83.79	-83.54	-84.06	-86.38	-84.08	-81.97	-81.03	-79.70	-77.31	-77.75	-76.73	-78.26	-79.12	
F62 -74.68	-83.22	-89.67	-94.20	-99.14	-96.15	-96.31	-94.53	-95.40	-90.54	-96.13	-87.92	-85.77	-85.93	-86.04	-85.03	-87.00	-85.23	-84.66	-85.12	-85.47	-84.28	-83.23	-81.32	-79.25	-77.93	-78.24	-77.84	-79.75	-80.12	
F63 -67.85	-76.90	-84.03	-89.87	-92.92	-94.40	-95.56	-96.37	-95.40	-89.91	-87.78	-87.48	-87.75	-87.43	-108.55	-92.51	-88.99	-88.60	-89.17	-87.09	-86.36	-82.07	-81.27	-80.61	-80.05	-79.80	-79.84	-79.80	-81.75		
D04 0.2456	0.2454	0.2452	0.2450	0.2448	0.2447	0.2445	0.2443	0.2441	0.2439	0.2437	0.2436	0.2434	0.2432	0.2430	0.2428	0.2426	0.2424	0.2423	0.2421	0.2419	0.2417	0.2415	0.2413	0.2411	0.2410	0.2408	0.2406	0.2404	0.2402	0.2400
D05 0.2817	0.2814	0.2812	0.2809	0.2807	0.2805	0.2802	0.2800	0.2798	0.2795	0.2793	0.2791	0.2788	0.2786	0.2783	0.2781	0.2779	0.2776	0.2774	0.2772	0.2769	0.2767	0.2765	0.2762	0.2760	0.2757	0.2755	0.2753	0.2750	0.2748	0.2746
D06 0.3185	0.3182	0.3179	0.3177	0.3174	0.3171	0.3168	0.3165	0.3162	0.3159	0.3156	0.3153	0.3150	0.3148	0.3145	0.3142	0.3139	0.3136	0.3133	0.3130	0.3127	0.3124	0.3121	0.3119	0.3116	0.3113	0.3110	0.3107	0.3104	0.3101	0.3098
D07 0.3562	0.3559	0.3555	0.3552	0.3548	0.3545	0.3542	0.3538	0.3535	0.3531	0.3528	0.3524	0.3521	0.3517	0.3514	0.3510	0.3507	0.3503	0.3500	0.3497	0.3493	0.3490	0.3486	0.3483	0.3479	0.3476	0.3472	0.3469	0.3465	0.3462	0.3458
D08 0.3948	0.3944	0.3940	0.3936	0.3932	0.3928	0.3924	0.3920	0.3916	0.3912	0.3908	0.3904	0.3899	0.3895	0.3891	0.3887	0.3883	0.3879	0.3875	0.3871	0.3867	0.3863	0.3859	0.3855	0.3851	0.3847	0.3843	0.3839	0.3835	0.3831	0.3827
D09 0.4343	0.4338	0.4334	0.4329	0.4324	0.4320	0.4315	0.4310	0.4306	0.4301	0.4296	0.4292	0.4287	0.4282	0.4278	0.4273	0.4268	0.4264	0.4259	0.4254	0.4250	0.4245	0.4240	0.4235	0.4231	0.4226	0.4222	0.4217	0.4212	0.4208	0.4203
D10 0.4747	0.4742	0.4737	0.4731	0.4726	0.4721	0.4716	0.4710	0.4705	0.4700	0.4694	0.4689	0.4684	0.4678	0.4673	0.4668	0.4663	0.4657	0.4652	0.4647	0.4641	0.4636	0.4631	0.4625	0.4620	0.4615	0.4610	0.4604	0.4599	0.4594	0.4588
D11 0.5162	0.5156	0.5150	0.5144	0.5138	0.5132	0.5126	0.5120	0.5114	0.5108	0.5102	0.5096	0.5090	0.5084	0.5078	0.5072	0.5066	0.5060	0.5054	0.5048	0.5042	0.5036	0.5030	0.5024	0.5018	0.5012	0.5006	0.5001	0.4995	0.4989	0.4983
D12 0.5587	0.5580	0.5574	0.5567	0.5560	0.5554	0.5547	0.5540	0.5533	0.5527	0.5520	0.5513	0.5507	0.5500	0.5493	0.5487	0.5480	0.5473	0.5467	0.5460	0.5453	0.5447	0.5440	0.5433	0.5427	0.5420	0.5413	0.5406	0.5400	0.5393	0.5386
D13 0.6023	0.6016	0.6008	0.6001	0.5993	0.5986	0.5979	0.5971	0.5964	0.5956	0.5949	0.5941	0.5934	0.5927	0.5919	0.5912	0.5904	0.5897	0.5889	0.5882	0.5875	0.5867	0.5860	0.5852	0.5845	0.5837	0.5830	0.5823	0.5815	0.5808	0.5800
D14 0.6471	0.6463	0.6455	0.6446	0.6438	0.6430	0.6422	0.6414	0.6405	0.6397	0.6389	0.6381	0.6372	0.6364	0.6356	0.6348	0.6340	0.6331	0.6323	0.6315	0.6307	0.6299	0.6291	0.6282	0.6274	0.6266	0.6258	0.6250	0.6242	0.6233	0.6225
D15 0.6931	0.6922	0.6913	0.6904	0.6895	0.6886	0.6877	0.6868	0.6859	0.6850	0.6841	0.6832	0.6823	0.6814	0.6805	0.6796	0.6787	0.6778	0.6769	0.6760	0.6751	0.6742	0.6732	0.6723	0.6714	0.6705	0.6696	0.6687	0.6678	0.6669	0.6660
D16 0.7405	0.7395	0.7385	0.7375	0.7365	0.7355	0.7345	0.7335	0.7325	0.7315	0.7306	0.7296	0.7286	0.7276	0.7266	0.7256	0.7246	0.7236	0.7226	0.7216	0.7206	0.7197	0.7187	0.7177	0.7167	0.7157	0.7147	0.7137	0.7127	0.7117	0.7108
D17 0.7892	0.7881	0.7870	0.7859	0.7849	0.7838	0.7827	0.7816	0.7805	0.7794	0.7783	0.7773	0.7762	0.7751	0.7740	0.7729	0.7718	0.7708	0.7697	0.7686	0.7675	0.7664	0.7654	0.7643	0.7632	0.7621	0.7610	0.7599	0.7589	0.7578	0.7567
D18 0.8394	0.8382	0.8370	0.8358	0.8346	0.8335	0.8323	0.8311	0.8299	0.8287	0.8276	0.8264	0.8252	0.8240	0.8228	0.8216	0.8205	0.8193	0.8181	0.8169	0.8157	0.8146	0.8134	0.8122	0.8110	0.8098	0.8087	0.8075	0.8063	0.8051	0.8040
D19 0.8911	0.8898	0.8886	0.8873	0.8860	0.8847	0.8834	0.8821	0.8808	0.8795	0.8783	0.8770	0.8757	0.8744	0.8731	0.8718	0.8705	0.8693	0.8680	0.8667	0.8654	0.8641	0.8628	0.8616	0.8603	0.8590	0.8577	0.8564	0.8552	0.8539	0.8526
D20 0.9445	0.9431	0.9417	0.9403	0.9389	0.9375	0.9361	0.9347	0.9333	0.9319	0.9305	0.9291	0.9277	0.9264	0.9250	0.9236	0.9222	0.9208	0.9194	0.9180	0.9166	0.9152	0.9138	0.9124	0.9110	0.9096	0.9083	0.9069	0.9055	0.9041	0.9027
D21 0.9997	0.9982	0.9967	0.9952	0.9936	0.9921	0.9906	0.9891	0.9876	0.9860	0.9845	0.9830	0.9815	0.9800	0.9785	0.9770	0.9754	0.9739	0.9724	0.9709	0.9694	0.9679	0.9664	0.9649	0.9634	0.9619	0.9604	0.9589	0.9574	0.9559	0.9544
D22 1.0568	1.0551	1.0535	1.0518	1.0502	1.0485	1.0469	1.0453	1.0436	1.0420	1.0403	1.0387	1.0370	1.0354	1.0338	1.0321	1.0305	1.0288	1.0272	1.0256	1.0239	1.0223	1.0207	1.0190	1.0174	1.0158	1.0142	1.0125	1.0109	1.0093	1.0077
D23 1.1159	1.1141	1.1123	1.1105	1.1087	1.1069	1.1052	1.1034	1.1016	1.0998	1.0980	1.0963	1.0945	1.0927	1.0909	1.0892	1.0874	1.0856	1.0839	1.0821	1.0803	1.0786	1.0768	1.0750	1.0733	1.0715	1.0698	1.0680	1.0662	1.0645	1.0627
D24 1.1771	1.1752	1.1733	1.1713	1.1694	1.1675	1.1655	1.1636	1.1617	1.1598	1.1578	1.1559	1.1540	1.1521	1.1502	1.1482	1.1463	1.1444	1.1425	1.1406	1.1387	1.1368	1.1349	1.1330	1.1311	1.1292	1.1273	1.1254	1.1235	1.1216	1.1197
D25 1.2407	1.2386	1.2365	1.2345	1.2324	1.2303	1.2282	1.2261	1.2240	1.2219	1.2199	1.2178	1.2157	1.2136	1.2115	1.2094	1.2074	1.2054	1.2033	1.2012	1.1992	1.1971	1.1950	1.1930	1.1909	1.1889	1.1868	1.1848	1.1827	1.1807	1.1786
D26 1.3068	1.3046	1.3023	1.3001	1.2978	1.2955	1.2933	1.2910	1.2888	1.2865	1.2843	1.2820	1.2798	1.2776	1.2754	1.2731	1.2708	1.2686	1.2664	1.2641	1.2619	1.2597	1.2575	1.2553	1.2530	1.2508	1.2486	1.2464	1.2442	1.2420	1.2398
D27 1.3757	1.3732	1.3708	1.3684	1.3659	1.3635	1.3610	1.3586	1.3562	1.3537	1.3513	1.3489	1.3464	1.3440	1.3416	1.3392	1.3368	1.3344	1.3319	1.3295	1.3271	1.3247	1.3223	1.3199	1.3175	1.3151	1.3128	1.3104	1.3080	1.3056	1.3032
D28 1.4475	1.4451	1.4422	1.4396	1.4369	1.4343	1.4316	1.4289	1.4262	1.4235	1.4211	1.4185	1.4159	1.4132	1.4106	1.4080	1.4054	1.4028	1.4001	1.3976	1.3950	1.3924	1.3898	1.3872	1.3846	1.3821	1.3795	1.3769	1.3743	1.3718	1.3692
D29 1.5226	1.5197	1.5168	1.5140	1.5111	1.5082	1.5054	1.5025	1.4997	1.4968	1.4940	1.4911	1.4883	1.4855	1.4826	1.4798	1.4770	1.4742	1.4714	1.4686	1.4657	1.4629	1.4601	1.4573	1.4545	1.4518	1.4490	1.4462	1.4434	1.4406	1.4379
D30 1.6012	1.5980	1.5949	1.5918	1.5887	1.5856	1.5825	1.5794	1.5764	1.5733	1.5702	1.5671	1.5640	1.5610	1.5579	1.5548	1.5518	1.5487	1.5457	1.5427	1.5396	1.5366	1.5336	1.5305	1.5275	1.5245	1.5215	1.5185	1.5155	1.5125	1.5095
D31 1.6836	1.6803	1.6769	1.6735	1.6702	1.6668	1.6634	1.6601	1.6567	1.6534	1.6500	1.6467	1.6434	1.6401	1.6367	1.6334	1.6301	1.6268	1.6235												

N27	65034	77233	77047	54277	54943	63194	75355	64328	66657	72639	68916	70825	60905	62989	65385	56005	46039	40390	37312	35709	33954	36990	49099	65355	77473	129939	296993	572692	851860	718282	412021		
N28	59026	66127	70259	55971	56345	57046	63899	54558	58683	66137	65170	65792	57746	59388	59866	54314	43849	35604	32366	30234	28302	29523	40584	55745	70727	126182	274944	475678	584131	428478	209074		
N29	50985	56198	61063	51006	52755	50587	51158	43541	47225	56325	57750	59052	54748	56087	54753	49673	43251	35350	30083	26158	24278	23919	34233	49233	69992	131766	246784	364771	367922	231057	96781		
N30	40194	46466	48851	40735	43229	42916	41426	35106	38049	44885	46703	50271	49188	49603	48721	43339	40800	35474	29685	24365	22737	21626	29404	44669	67396	128169	202369	262097	225946	116619	42418		
N31	32791	38667	38739	33112	33966	35632	35121	29527	31592	35190	36132	39297	40590	41861	40777	35522	34810	33220	29146	23816	22513	21731	25332	39495	63409	112091	148329	170767	128777	57111	18438		
N32	26779	30998	30818	27021	26688	28794	28357	24711	26040	27304	28354	30252	31003	32845	33046	28087	28609	29383	27140	22956	20519	19565	21557	35231	59064	89797	99531	101029	67060	27643	8231.6		
N33	21174	24803	24561	21294	20373	22734	21943	19334	19721	20283	22167	23937	23517	24379	25869	22460	24626	24905	22963	20825	17844	16721	18303	29935	48723	66532	65672	56417	32615	12167	3448.5		
N34	15543	19429	18430	15880	15100	16759	15610	13544	13375	14668	16884	18871	18722	18590	19172	17529	20454	20027	17849	17282	15318	15391	16430	23729	35545	46676	43087	31116	15240	4622.4	1196.3		
N35	11074	14746	13021	11318	11080	11857	10535	9071.8	9153.5	10891	12100	13423	13959	13631	13374	12554	14989	14600	13282	13155	11733	13308	14872	18890	24295	28910	25386	16667	7517.4	1769.8	372.01		
N36	8063.7	10718	8927.8	7966.0	7954.2	8413.8	7584.7	6429.2	6668.3	7912.6	8156.4	8572.4	9241.6	9262.2	9187.0	8380.0	9491.1	9687.6	9774.1	9585.0	8641.0	10461	12281	14376	15828	15629	12579	7542.3	3299.7	699.22	127.95		
N37	5579.9	7232.0	5896.5	5342.4	5529.4	6050.6	5548.5	4679.9	4724.6	5237.0	5312.6	5556.1	5978.6	5945.9	6001.2	5351.7	5813.2	6361.6	6982.7	6806.1	6566.6	7816.2	8969.7	9791.1	10116	8644.9	5594.9	2947.6	1201.5	236.46	50.288		
N38	3660.6	4631.9	3782.0	3554.0	3882.1	4301.2	3788.2	3094.7	3073.3	3388.5	3572.4	3826.3	4115.9	3848.7	3753.9	3401.1	3693.0	4212.3	4742.4	4694.6	4822.6	5578.4	6223.4	6570.3	6224.6	4805.3	2510.5	1149.9	428.02	73.016	40.260		
N39	2451.6	3052.0	2462.6	2454.8	2701.9	2879.9	2516.2	1986.3	1970.7	2224.8	2389.8	2510.6	2621.3	2340.3	2308.5	2145.4	2363.8	2776.2	3040.2	2991.0	3206.6	3590.5	4066.8	4184.1	3400.7	2300.2	1089.4	447.38	153.45	23.465	45.138		
N40	1619.3	2074.6	1583.4	1582.6	1763.5	1834.0	1574.2	1260.2	1294.3	1402.1	1458.3	1450.0	1468.7	1288.6	1363.3	1331.0	1495.8	1722.1	1838.6	1847.8	2074.7	2231.3	2468.2	2294.7	1631.5	949.15	424.41	166.03	51.607	6.7670	45.100		
N41	982.38	1326.3	973.26	959.24	1050.9	1068.5	858.33	744.14	829.82	857.60	842.94	812.12	831.79	723.97	797.48	805.01	917.07	1012.8	1109.3	1210.2	1333.5	1407.9	1414.7	1116.5	712.05	366.94	154.27	62.599	17.781	2.8902	43.531		
N42	559.59	801.97	590.94	560.59	570.14	570.07	441.00	428.44	513.44	509.34	483.11	472.63	466.78	408.14	449.80	443.00	503.02	542.48	648.21	783.12	818.78	829.53	748.08	508.35	280.57	132.16	51.527	21.089	5.7216	1.2082	41.131		
N43	311.72	452.26	341.63	311.89	298.49	296.60	243.05	266.12	315.43	285.84	267.08	259.91	236.88	207.13	222.80	211.03	240.93	268.09	351.68	453.51	472.69	455.83	358.53	206.85	103.39	45.136	16.576	5.5499	1.1879	0.9027	36.637		
N44	169.68	239.35	178.44	164.85	152.13	148.30	137.29	172.38	192.97	159.46	138.54	126.42	111.82	93.173	92.717	91.467	109.10	127.54	181.10	233.85	246.11	239.27	169.73	76.829	36.747	15.236	5.1847	1.0163	0.1858	1.2911	32.235		
N45	81.786	121.41	84.666	81.660	79.681	78.907	77.345	103.17	113.45	92.542	68.828	57.519	50.597	37.522	33.149	36.609	47.387	54.895	82.849	112.99	119.13	115.14	76.344	28.340	11.652	4.4790	1.2523	-0.1501	0.1087	1.4566	27.688		
N46	34.401	57.447	38.938	39.926	41.450	43.409	45.297	54.983	60.493	52.144	33.413	25.366	20.018	12.808	11.334	13.548	17.845	20.532	31.125	48.032	53.157	48.112	29.404	9.4621	3.2046	1.0200	0.1508	-0.1471	0.2992	1.2458	21.402		
N47	14.599	25.105	17.415	18.311	18.017	21.264	26.064	29.209	30.549	26.836	16.089	11.018	7.6411	4.1295	3.6462	4.5463	5.7951	6.7475	9.5651	16.130	19.956	17.000	9.3864	2.6096	0.7768	0.2122	0.0214	-0.0118	0.3312	0.8860	14.571		
N48	6.0655	10.083	6.7792	6.7683	6.5345	9.1416	12.917	15.288	15.165	12.710	7.4520	4.6330	3.0609	1.3756	0.9208	1.3419	1.6967	1.8734	2.5597	4.3964	6.1000	4.8768	2.2767	0.5247	0.0722	-0.0227	9.6e-4	-0.0267	0.2702	0.6419	8.2911		
N49	2.5061	3.6136	2.2706	1.9711	2.0213	3.5677	5.5743	7.8399	7.7926	5.9892	3.3414	1.7142	0.9998	0.3713	0.1577	0.3096	0.3850	0.3988	0.6132	1.0605	1.5677	1.1634	0.4705	0.1001	-0.0409	-0.0489	0.0142	0.0276	0.2706	0.4230	4.0321		
N50																0.0510	0.0522	0.0533	0.1262	0.2087	0.3256	0.2438	0.1037	0.0316	0.0116	0.0055	0.0252	0.0680	0.2527	0.3298	1.8604		
N51																																	0.7945
PIA	0.000	0.028	0.054	0.076	0.097	0.120	0.143	0.162	0.182	0.204	0.226	0.248	0.270	0.292	0.315	0.334	0.354	0.374	0.395	0.414	0.433	0.453	0.475	0.500	0.528	0.565	0.610	0.667	0.743	0.833	0.939		
z	32.52	33.54	32.65	32.07	31.98	32.17	31.91	31.51	31.60	31.57	31.22	31.08	30.90	30.59	30.51	30.04	30.24	30.28	30.36	30.40	30.31	30.37	30.39	30.55	30.90	31.57	32.08	32.73	33.37	33.36	33.33		
Z	32.52	33.56	32.69	32.14	32.07	32.29	32.05	31.67	31.77	31.77	31.43	31.32	31.16	30.87	30.37	30.59	30.65	30.75	30.82	30.75	30.82	30.75	30.83	30.87	31.06	31.44	32.15	32.69	33.40	34.10	34.18	34.25	
RR	2.93	3.25	3.09	2.58	2.52	2.71	2.69	2.31	2.41	2.68	2.69	2.72	2.74	2.79	2.81	2.49	2.47	2.42	2.41	2.30	2.24	2.35	2.62	3.00	3.46	4.53	5.96	8.08	12.16	16.29	20.79		
LWC	0.17	0.18	0.17	0.14	0.14	0.15	0.16	0.14	0.14	0.16	0.17	0.17	0.18	0.19	0.19	0.17	0.17	0.18	0.19	0.18	0.18	0.20	0.22	0.23	0.25	0.31	0.40	0.50	0.76	1.07	1.49		
W	6.57	6.73	6.57	6.66	6.68	6.81	6.84	6.95	6.90	6.72	6.57	6.51	6.53	6.42	6.45	6.48	6.58	6.68	6.83	6.99	7.09	7.10	7.00	6.77	6.50	6.20	5.88	5.53	5.11	4.61	4.16		

6.4 Raw data

6.4.1 Format Description

Each data block in a **raw data** file begins with a header line which contains the date, the time and the time zone of the following data block. This line is preceded by the letter T and a colon (T means time). The format of the date/time stamp is YYMMDDhhmmss, which means year, month, day, hour, minute and second with 2 digits each. Date, time and time zone are separated by a space character. The header line is supplemented with the version number of the MRR firmware (following the identifier DVS), the serial number (of the MRR (following the identifier DSN), the calibration constant of the MRR (following the identifier CC) and the percentage of valid spectra, number of valid spectra and number of total spectra (following the identifier MDQ).

The next data lines contains the measuring heights. It begins with the capital letter M, a colon, the small letter h, two space characters, and an equals sign (M means measured value, h means height). The following numbers (9 digits decimal each) represent the measuring heights in meters.

The height line is followed by the line of the transfer function. It starts with the capital character M, a colon, the capital letters T and F and one space character. The rest of that line represents the values of the transfer function for each height step (9 digits decimal each).

The line of the transfer function is followed by 64 data lines. Each one starts with the capital character M, a colon, the small letter f, and a 2-digit number of the spectra line (0 to 63). The rest of these lines represent the received spectral signal power in engineering units for each height step (9 digits decimal each).

The raw spectra include the receiver noise floor.

6.4.2 Example

T:090612024311 UTC DVB S.10 DBN 020704 CC 2066000 MDQ 100 88 58

M:ZF = 0.003292 0.111523 0.041975 0.098863 0.175883 0.284184 0.334019 0.429514 0.532373 0.603018 0.675270 0.756816 0.794239 0.836626 0.877178 0.893358 1.000000 0.868133 0.924280 0.883813 0.890396 0.903978 0.875897 0.853772 0.843347 0.834568 0.780658 0.774897 0.752401 0.689026 0.640604 0.422497

M:F01=	2780	1272	107	33	19	20	25	23	22	20	22	28	27	22	18	18	20	18	21	25	21	15	14	12	12	12	11	8	7	5					
M:F02=	541	246	33	20	22	22	27	27	26	25	26	32	34	22	28	25	25	24	28	30	25	17	16	13	13	14	15	10	6	6					
M:F03=	19	22	17	20	25	24	27	28	28	26	24	31	35	33	28	24	29	28	25	27	28	25	19	21	19	14	14	13	11	8	6				
M:F04=	4	9	18	22	25	24	27	30	29	26	24	26	30	27	24	27	34	30	25	24	25	24	20	20	20	14	15	14	12	12	9	6			
M:F05=	3	9	19	16	27	24	26	30	29	31	26	21	25	22	20	30	36	31	26	23	23	22	18	19	17	12	13	13	11	12	11	7			
M:F06=	3	9	20	32	32	24	24	28	30	33	27	22	27	24	21	30	35	30	27	23	23	19	18	16	14	11	11	11	11	12	13	12	7		
M:F07=	3	18	38	38	27	24	25	27	30	30	27	25	30	27	24	33	31	29	26	24	20	16	13	11	13	13	11	12	13	11	12	10	6		
M:F08=	3	10	23	49	48	32	26	24	22	29	30	27	29	30	31	34	32	31	32	28	25	22	24	16	13	13	16	15	10	10	11	6	6		
M:F09=	4	11	28	161	24	36	29	23	24	30	33	28	29	35	38	35	36	33	32	27	24	21	23	15	15	17	17	15	10	9	10	6	6		
M:F10=	5	13	34	70	56	38	34	30	32	34	33	33	33	43	46	38	41	37	30	25	24	19	17	10	17	14	12	12	9	5	4	5	4		
M:F11=	4	16	44	89	60	39	38	35	37	34	35	39	36	47	54	48	47	39	30	24	22	19	20	21	26	20	16	14	13	14	8	4	4		
M:F12=	5	18	55	107	71	48	47	42	42	41	40	43	37	46	57	54	55	45	30	24	23	20	20	23	29	21	16	15	14	13	7	4	4		
M:F13=	7	19	65	137	93	75	60	46	47	52	51	47	38	47	56	52	61	52	34	23	23	24	21	29	33	28	21	18	17	13	6	5	5		
M:F14=	9	23	84	198	141	127	88	49	53	61	56	48	38	53	62	59	68	60	42	29	28	29	24	37	40	38	31	24	21	15	9	6	6		
M:F15=	12	34	139	329	220	182	124	60	62	75	64	54	45	65	80	78	80	71	52	39	34	35	41	47	49	41	36	29	24	17	12	7	7		
M:F16=	15	32	236	522	336	215	136	69	74	88	74	65	59	78	92	93	91	84	63	49	42	46	65	64	57	42	37	31	28	19	12	8	8		
M:F17=	24	75	325	698	485	275	150	81	85	90	85	79	83	99	100	101	102	83	58	54	61	78	72	61	48	41	33	21	22	12	7	7	7		
M:F18=	48	120	374	710	569	364	199	116	115	112	105	94	106	132	127	108	112	125	106	91	68	70	77	73	61	48	42	32	30	23	12	7	7		
M:F19=	98	235	526	747	595	418	242	146	146	138	131	115	126	152	157	123	132	157	136	101	88	78	71	73	63	44	38	29	27	25	15	9	9		
M:F20=	177	377	803	915	652	462	268	117	240	236	188	149	155	169	192	159	168	192	170	139	115	101	76	65	63	43	36	29	27	29	19	11	11	11	
M:F21=	290	582	1054	1084	739	498	303	237	274	295	262	195	187	206	243	201	190	179	179	130	125	121	96	67	71	52	40	36	36	38	24	12	12	12	
M:F22=	492	873	1270	1406	1049	557	352	281	293	305	310	266	224	259	267	222	207	171	152	125	117	124	111	93	91	66	50	47	49	48	31	16	16	16	
M:F23=	814	1437	1629	1947	1531	666	418	340	355	315	349	369	345	329	261	220	224	178	142	109	122	129	116	125	114	88	80	64	62	61	40	22	22	22	
M:F24=	1103	2015	2193	2970	2137	816	526	473	506	421	509	486	480	405	278	248	249	225	176	140	141	135	131	188	147	131	124	91	88	88	55	33	33	33	
M:F25=	1215	2304	3049	4986	3612	973	722	714	711	661	829	698	523	405	287	289	322	323	297	252	179	161	194	220	207	195	176	129	133	130	81	48	48	48	
M:F26=	1202	2861	4088	5658	3957	1032	867	906	902	1013	1097	733	513	352	284	358	464	482	382	369	262	252	330	337	397	270	243	192	179	142	106	61	61	61	
M:F27=	1692	3945	4978	5726	3427	893	775	923	1093	1218	1081	731	502	394	351	445	465	628	732	577	586	405	437	516	481	421	367	299	263	248	200	124	79	79	79
M:F28=	3428	6511	6513	6285	3598	893	731	1024	1164	1418	1153	719	516	513	543	565	607	1058	830	791	549	632	668	614	557	452	349	317	349	282	146	87	87	87	
M:F29=	6270	5873	8179	7200	3957	1145	965	1395	1737	2134	1536	855	663	639	762	756	1113	1595	1225	933	714	817	814	673	573	450	403	404	446	355	166	105	105	105	
M:F30=	9754	9622	12394	7165	4522	2175	1524	2155	2896	2947	1922	1066	893	830	948	934	1443	2246	2014	1453	1050	1073	1003	695	466	385	471	517	487	369	204	128	128	128	
M:F31=	13520	15729	2698	7632	4648	1740	2698	3354	4341	3500	2201	1444	1043	1018	1095	1059	1803	2799	3242	2939	1587	1295	1095	675	317	315	525	557	425	331	251	187	187	187	
M:F32=	15274	23192	21914	10788	11365	9077	5307	4776	5807	3976	2625	1708	1151	1200	1387	1756	2922	3657	4269	3481	2313	1409	825	465	161	207	414	451	340	289	266	227	227	227	
M:F33=	13520	24671	25500	15261	18222	15980	10203	7815	7471	4865	3160	2005	1306	1648	2126	3210	4680	4508	6176	3876	2487	1273	441	252	62	32	211	307	320	276	245	176	176	176	
M:F34=	9754	21874	22408	17097	22023	19192	16391	12855	11468	7592	4160	2636	2145	2913	3740	4692	5650	4499	3363	2929	1955	825	194	64	26	34	99	235	324	273	218	116	116	116	
M:F35=	6270	15310	16602	15558	19843	18169	13653	18327	16864	11037	5459	4243	4228	5146	5376	5022	4785	3683	2351	1622	952	435	84	22	17	18	56	191	298	227	211	110	110	110	
M:F36=	3428	9683	12461	12216	15018	13796	16298	18613	17631	10864	6094	6075	6527	6463	5080	3520	2864	2397	1243	674	375	171	40	15	15	16	36	163	246	176	178	103	103	103	
M:F37=	1692	5905	1128	10133	5897	8186	5553	13447	12424	7651	5677	6779	7892	7002	3872	1817	1248	1158	474	212	126	64	24	16	16	16	31	126	175	119	114	68	68	68	
M:F38=	1202	4727	11461	11332	6377	3700	4043	6282	5638	4052	4089	5560	6861	5664	2461	776	450	449	161	64	42	31	19	16	16	18	27	87	53	64	53	32	32	32	
M:F39=	1215	4382	11578	12064	4531	1380	1280	1867	1806	1551	1950	2962	3602	2693	1117	307	172	177	65	28	22	22	18	14	15	17	19	37	35	25	25	21	16	16	
M:F40=	1303	4033	10911	16304	2964	545	423	572	568	463	597	958	1076	770	869	128	84	80	33	19	16	18	13	15	18	17	17	17	15	14	10	10	10		
M:F41=	814	3225	9611	8782	1958	2860	208	227	195	151	155	230	224	179	115	60	50	38	23	20	16	17	17	13	15	18	16	15	16	14	13	9	9	9	
M:F42=	492	2621	7508	7183	1576	130	97	97	79	64	65	76	66	62	51	37	34	24	22	20	19	18	17	14	14	16	14	14	12	12	12	12	12	12	
M:F43=	290	1436	4351	4426	1007	58	41	42	38	38	43	39	36	41	34	29	25	21	23	21	21	21	20	18	16	15	15	13	12	12	12	12	12	12	
M:F44=	177	678	2171	2315	502	33	25	28	32	33	26	26	33	29	25	23	21	22	22	23	22	22	20	19	16	16	13	11	11	13	14	8	8	8	
M:F45=	98	318																																	

6.5 Removing of the Software

If you want to remove the program from your PC you must be logged in as administrator. If still active you must stop the MRR-2 data-, error- & communication service using the `services` program in the program group `control panel/Administrative Tools`.

Then activate the folder `software`, select the entry `METEK MRR Software` and press the button `Add/Remove`. Finally you must manually remove the empty directory (`C:\METEK`) and possibly some data files and directories.

7 Detailed description of the MRR-2 control program

The MRR-2 generates Doppler spectra at 31 height ranges. The data processing is performed by a DSP which is located in the Radar Control and Processing Device (RCPD) at the antenna. The measured data are transmitted by a serial RS-232 port. This port is also used for the device control. If the MRR-2 is connected to a PC, the control, the calculation of further values, and the recording of the data can be done with the MRR-2-control program described below.

The software is divided into two components :

- Communication-, Data-, and Error- Service (CDES)
- Control Program User Interface (CPUI)

CDES communicates directly with the connected MRR-2, and CPUI performs the operational control of the MRR-2 using CDES. By means of this the user can interrogate or change the system status in a comfortable way.

Windows® Service Programs

Service programs are software components, which are started automatically when the machine is turned on and the operating system boots. They offer their 'services' e.g. control functions and data to other programs. The management of those programs must be provided by the operating system. The starting of a service program needs no manual operation. Only take care that the corresponding service is not deactivated.

Various details of the usage of services depend on the operating system. For this reason the used operating system must be Windows® 2000 or XP. (Windows® Vista and Windows 7 are not supported).

7.1 Communication-, Data-, and Error-Service (CDES)

7.1.1 Communication Service

This service is needed for the communication between the control program user interface (CPUI) and the control port of the MRR-2, which is implemented as a serial interface. With CDES the system settings of the MRR-2 can be retrieved and any changes entered by the user are translated to the corresponding commands and transmitted to the MRR-2. (Factory setting of the serial port of the MRR-2 is 57600 baud, 8 bit, no parity, XON/XOFF handshake protocol.)

7.1.2 Data Recording

The second function of CDES is the recording of the “averaged” or “instantaneous” measured data of the MRR-2. The data is ASCII formatted, so that it is directly readable.

CDES creates one file each day, whose name is constructed from the actual month, the day (2 characters each) and an additional extension. The boundary between two days is defined as 0:00 (selected time zone including UTC). The file name extension is `.MRR`.

All files of a month are stored in a separate directory which will be created automatically if it is not already existing. The names of the directories are constructed from the actual year (4 digits) and the respective month (2 digits).

The path names for the data registration and the port settings may be changed with the MS registry editor `regedit.exe` at the key

```
HKEY_LOCAL_MACHINE\
  System\
    CurrentControlSet\
      Services\
        MrrSrvc\
          Parameters
```

The variables of this key are shown with their default settings. Change the underlined values, if necessary :

Port	REG_SZ	<u>COM1</u>
BaudRate	REG_DWORD	<u>57600</u>
AveragedDataFile	REG_EXPAND_SZ	<u>%MetekRoot%\ActData\Data%s</u>
AveragedDataPath	REG_EXPAND_SZ	<u>%MetekRoot%\Data</u>
InstantaneousDataFile	REG_EXPAND_SZ	<u>%MetekRoot%\ActData\InstData%s</u>
InstantaneousDataPath	REG_EXPAND_SZ	<u>%MetekRoot%\InstData</u>

The common root directory is defined by the environmental variable

MetekRoot

It also can be changed with the registry editor at the following key :

```
HKEY_LOCAL_MACHINE\
  System\
    CurrentControlSet\
      Control\
        Session Manager\
          Environment
```

The variable is :

```
MetekRoot          REG_SZ          C:\METEK
```

The default settings are :

```
C:\METEK\Data      for averaged data
C:\METEK\ActData   for actual data( raw, instantaneous and averaged)
C:\METEK\Instdata  for instantaneous data
C:\METEK\Rawdata   for raw data,
                   not processed, only for testing purposes
C:\METEK           as the common root directory
```

The file `C:\METEK\Data\200506\0611.MRR` e.g. would contain the averaged data from June, 11th of 2005.

7.1.3 Error Protocol

The third function of CDES is the recording of all error messages which are caused by the operation of the MRR-2 (except messages which are generated from user input errors).

The error recording is done by the event logging function of the operation system. At the item `application` you find a chronologically sorted list of error messages, which occurred during the operation. Use the Windows event viewer to look at the messages or to store them in other formats. You also can define, how the system shall act if more than the storable number of errors occur. The event viewer is located in the program group

Programs/Administrative Tools.

7.2 Control Program User Interface (CPUI)

CPUI provides the user access to the MRR-2 through CDES. The correct installation and the automatic start of the service program are required for a successful start of CPUI. CPUI allows controlling the MRR-2 also by PCs which are not connected directly to the MRR-2.

It is only necessary that there is a network connection to that PC, on which CDES was started. This network connection may be either a local connection (ethernet) or a remote access connection (RAS) which is built up using the public telephone. (Make sure that you have purchased the required number of program licenses.)

For this remote operation a login at the remote CDES is necessary when you start the program (e.g. by a mouse click on a program icon you created before, or by the command line `C:\METEK\MrrCtrl`). This ensures that only one user is accessing the MRR-2.

There are no special network installations needed, because no network protocol dependent functions are used between the service and the user interface.

The following picture shows an example for a remote access, where the network connection is performed by a RAS connection. The communication of the user interface on PC #2 with the MRR-2 uses the network and the communication service program on PC #1. The data recording and the event logging is executed on PC #1 which is connected directly to the MRR-2:

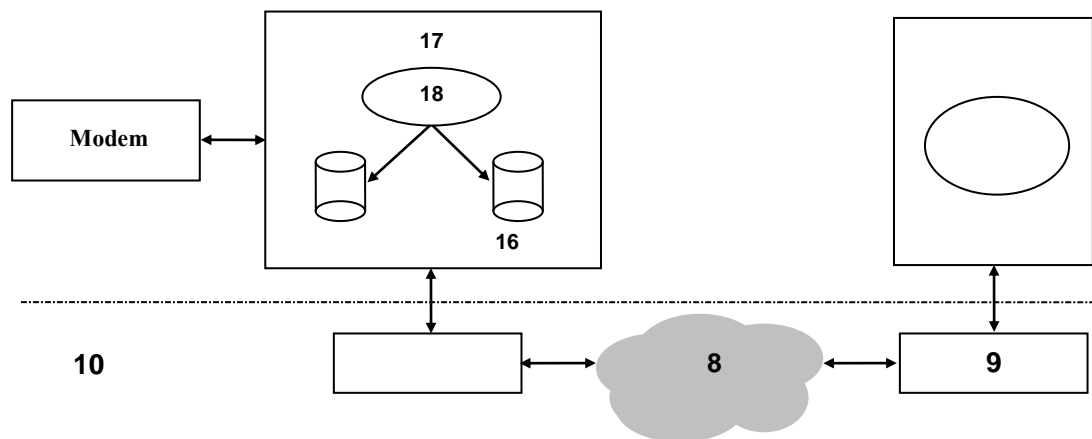

Figure 17 Remote Acces

The software is supplied on a CD-ROM with the following files:

MrrSrvc.exe	the service program
MrrCtrl.exe	control program (GUI)
Messages.dll	used for error messaging
MFC71.dll	used for runtime environment
msvcr71.dll	used for runtime environment
MrrXXXXXX.inf	installation file (XXXXXX stands for the serial number of the MRR)
MrrCtrl_D.hlp	help file German
MrrCtrl_E.hlp	help file English
MrrCtrl_D.cnt	help file German
MrrCtrl_E.cnt	help file English
MrrView.bat	
sbsize.exe	
setcolor.exe	
gzip.exe	data compression tool
tail.exe	data viewer

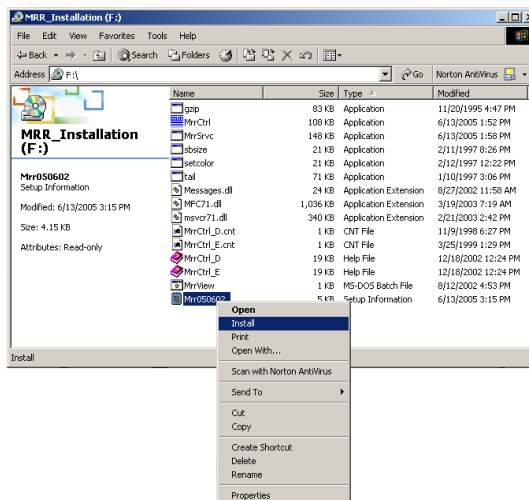

Figure 18 Directory Listing of the Installation CD-ROM

After installation of the MRR software the port settings may be changed with the MS registry editor regedit.exe at the key

```
HKEY_LOCAL_MACHINE\
  System\
    CurrentControlSet\
      Services\
        MrrSrvc\
          Parameters
```

The port variables of this key are shown with their default settings. Change the underlined values, if necessary :

Port	REG_SZ	<u>COM2</u>
BaudRate	REG_DWORD	<u>57600</u>

(You must be logged in with administration rights to change Windows® Registry parameters)

Every time when you change one ore more MRR parameters in the Windows® Registry you have to restart the MRR service because these parameters are only read from the Registry when the service starts.

Open the Start/Settings/Control Panel/Administrative Tools/Services menu in Windows® 2000. After selecting the MRRService, stop and start it directly with the short cuts or open the **Properties menu** and use the **Stop** and **Start** buttons.

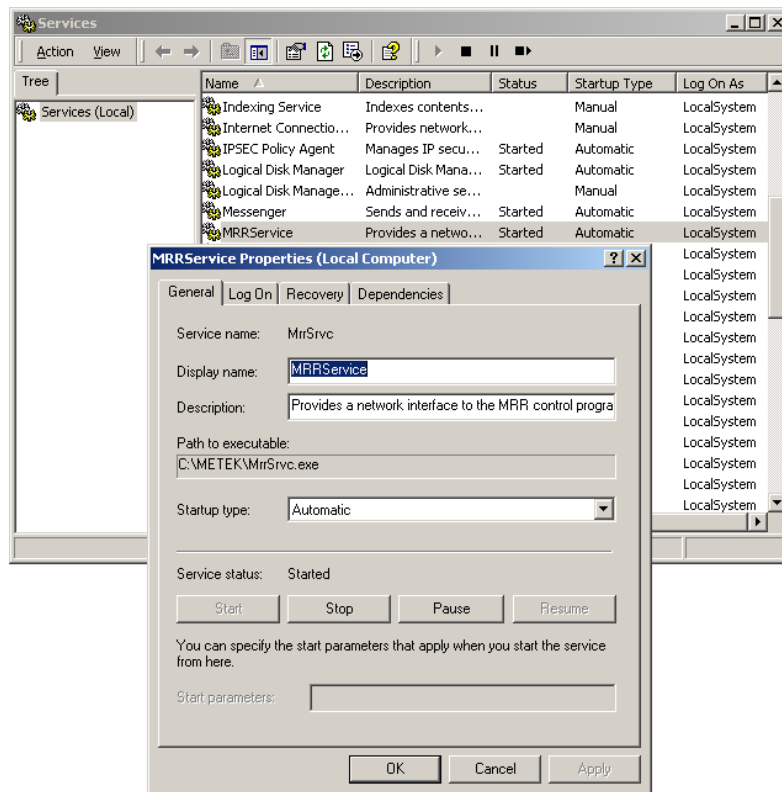

Figure 19 Administrative Tools / Services – Menu (Windows® 2000)

8 MRR-2 Specifications

RCPD with Radar module

Operating Frequency:	24.230 GHz
Operating Mode:	FMCW
Modulation:	1.5 - 15 MHz
Output Power:	50 mW (+17 dBm) (antenna foot point)
OoB and Spurious Emission:	< -80 dBm/MHz (antenna foot point)
2 nd Harmonic:	-37 dBm
ITU-Designation:	30M0N0N
Power Supply:	24 VDC / 1A

Antenna

Type:	parabolic offset antenna
Diameter:	600 mm
3 dB Beamwidth:	approx. 1.5 °
Gain:	40.1 dBi

Junction Box / Power Supply:

Input Voltage:	230 VAC or 24 VDC
Output Voltage	24 VAC / 1.5 A
Dimensions:	205 x 145 x 65 mm
Weight:	1.3 Kg

Antenna Heating (Option)

Power Supply:	230 VAC
Power Output:	approx. 200 W

Complete System:

Weight:	17.5 Kg
Dimensions:	800 x 600 x 850 mm

CETECOM ICT Services GmbH
EC Identification number 0682
 authorized by the German Government



to act as Notified Body in accordance with the R&TTE Directive 1999/5/EC of 09. March 1999.

**CERTIFICATE
EXPERT OPINION**

Registration-No.: **E814169R-EO**
 Certificate Holder: **METEK
Meteorologische Meßtechnik GmbH
Fritz-Straßmann-Str. 4
D-25337 Elmshorn**

Product Designation: **Mikro-Regen-Radar (MRR) / PreWeS24**
 Product Description: **Radar System**

Product Manufacturer: **METEK
Meteorologische Meßtechnik GmbH
Fritz-Straßmann-Str. 4
D-25337 Elmshorn**

Essential requirements	Specifications / Standards	Submitted documents	Result
Radio spectrum (R&TTE, Article 3.2)	EN 300 440-1 V1.3.1 (2001-09) EN 300 440-2 V1.1.1 (2001-09)	Test Report	conform

Marking: **The product shall be signed with CE, our notified body number and the Class II identifier (Alert sign) as shown right hand.** CE 0682 ⚠

The scope of this evaluation relates to the submitted documents only.
 The certificate is only valid in conjunction with the following **number** of annexes.

Number of annexes: **1**

Saarbrücken, 18.10.2004
 Place, Date of Issue

 Signed by Ernst Hussinger
 Notified Body



CETECOM ICT Services GmbH, Untertürkheimer Straße 6-10, D-66117 Saarbrücken, Germany
<http://www.cetecom.de>